

LUGO – 08

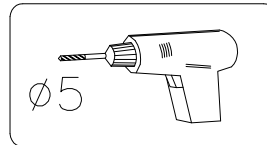

#	ART. NR	QUANTITY
1	401	1
2	402	1
3	403	1
4	101	1
5	102	1
6	501	2
7	830	1
8	831	1
9	840	2
10	860	1
11	001	2
12	601	2

VERSION-L

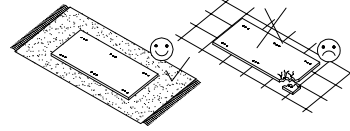
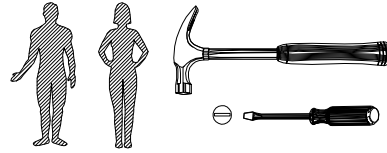
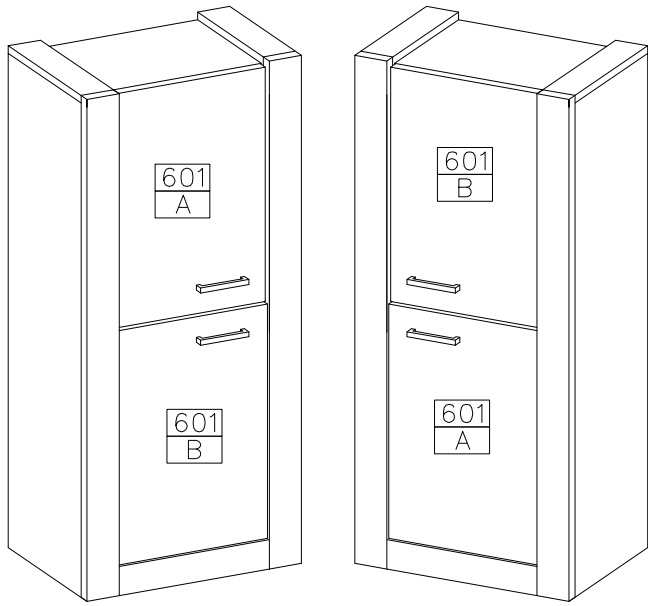

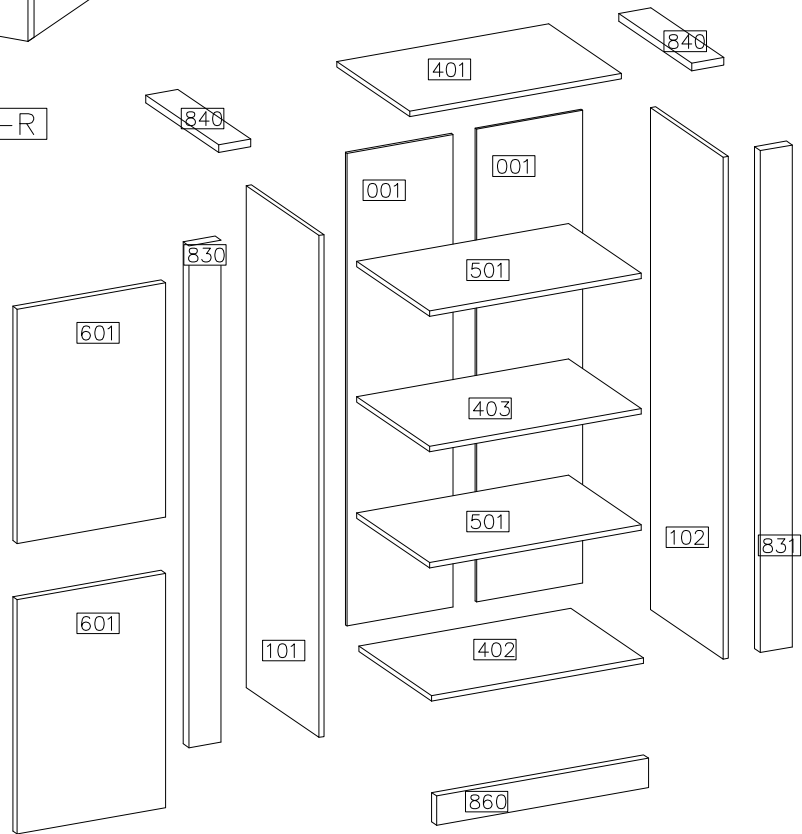
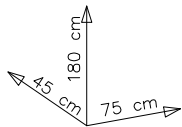
VERSION-R

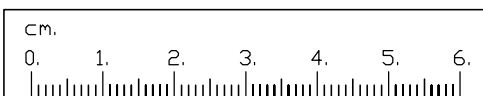

	ø15/12mm		ø8x30mm		H=2	ø35/KR90	ø4.0x16mm
D1	C	E	A	J4	H5	G9	P1
30	30	30	12	8	4	4	8
			M4.0x23	4.0x27mm			
F1	F10	S1	R2	R2	Z1		
5	40	2	4	4	1		



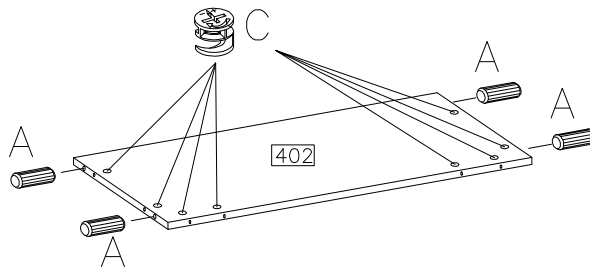

1

$\varnothing 8 \times 30 \text{mm}$  A 4	$\varnothing 15 / 12 \text{mm}$  C 8
-----------------------------------------------------------------------------------------------------------------------------------	-------------------------------------------------------------------------------------------------------------------------------





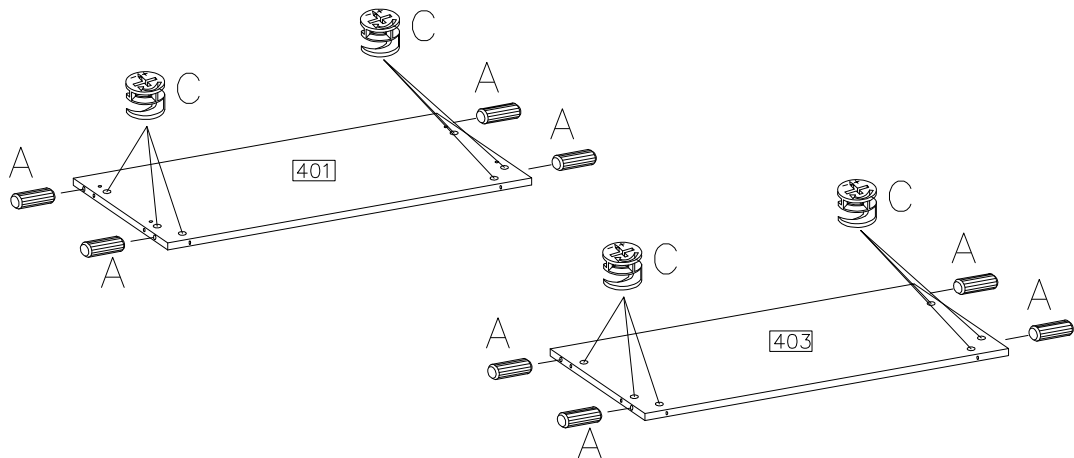

2

$\varnothing 8 \times 30 \text{mm}$  A 8	$\varnothing 15 / 12 \text{mm}$  C 12
------------------------------------------------------------------------------------------------------------------------------------	---------------------------------------------------------------------------------------------------------------------------------



3

$\varnothing 15 / 12 \text{mm}$  C 10	 D1 12
 F1 4	 J4 8

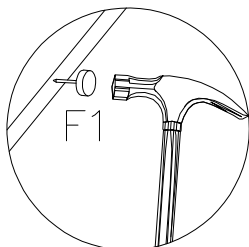
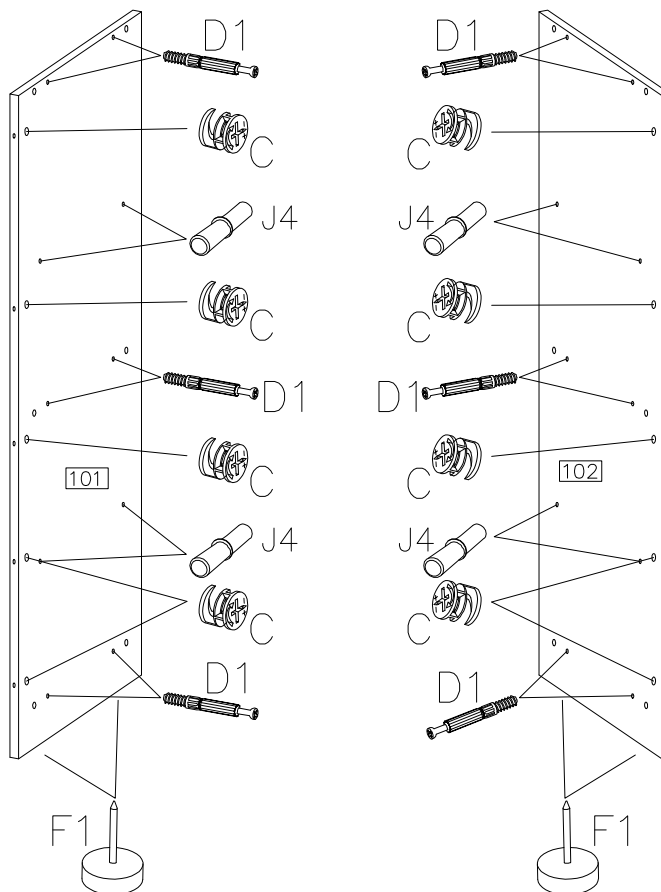

4



12

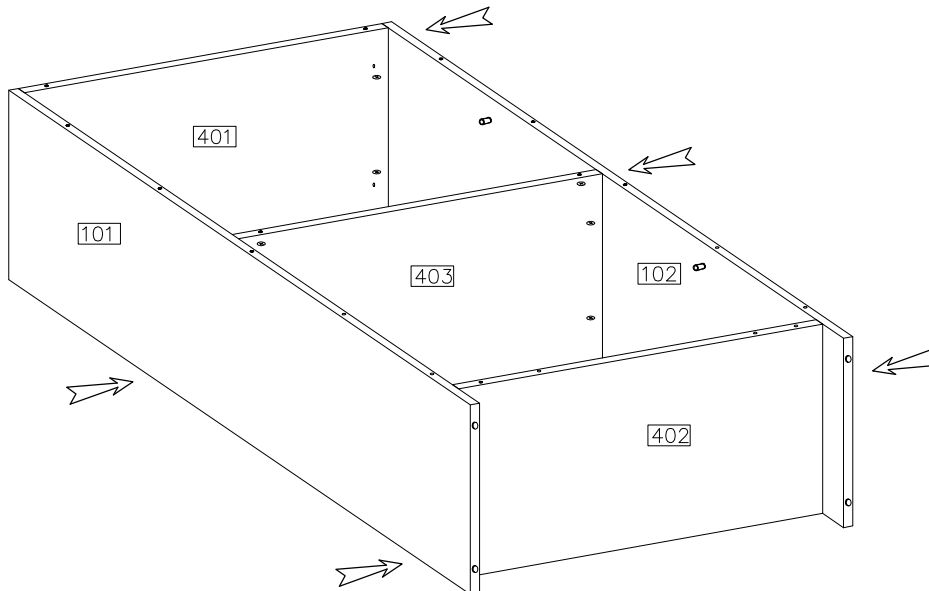
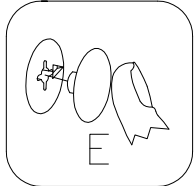
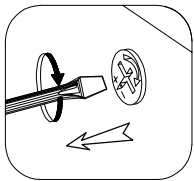

5

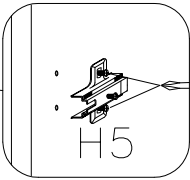
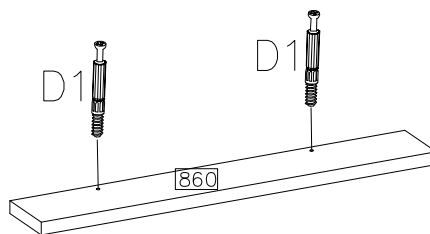
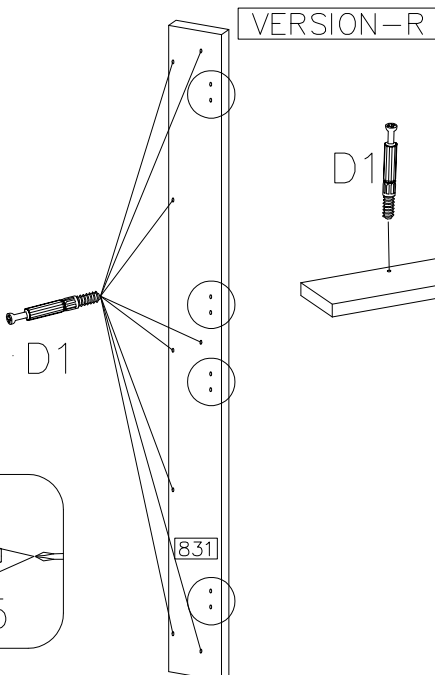
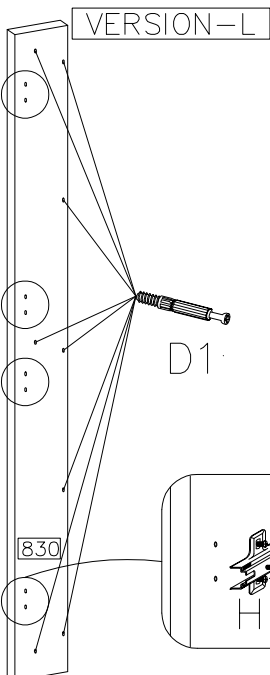

H=2		D1
H5	4	18

6

	E
18	
	F1
1	

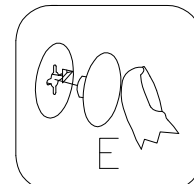
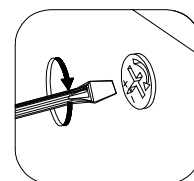
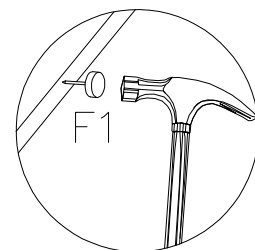
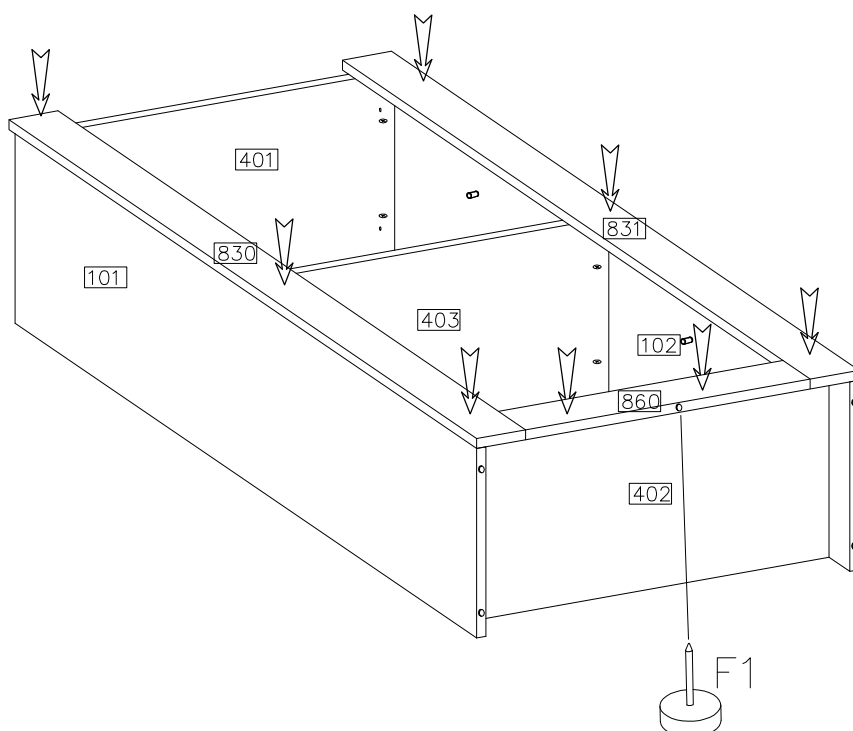

7

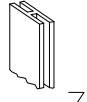
	
F10	Z1
40	1

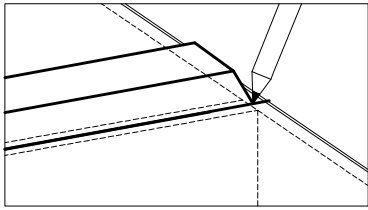
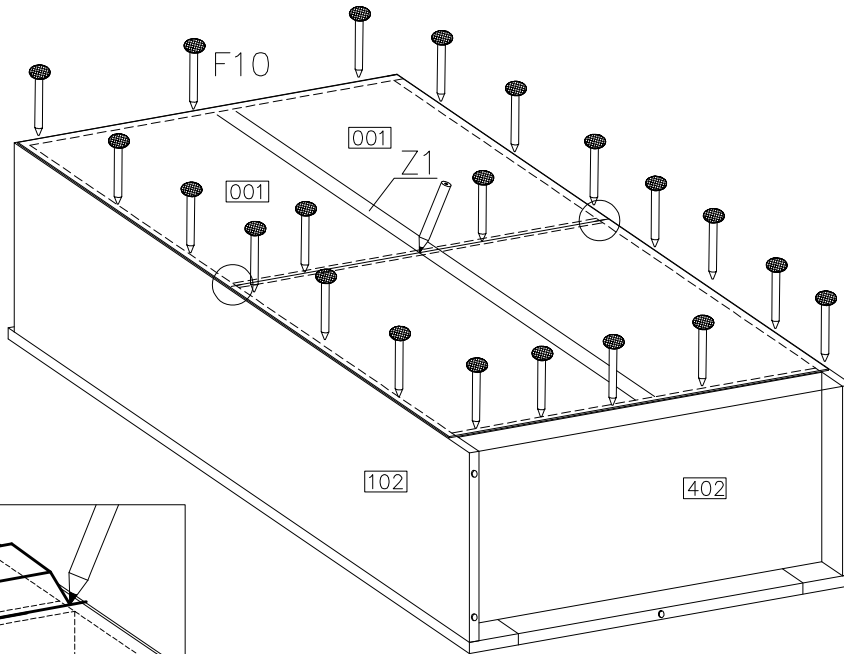
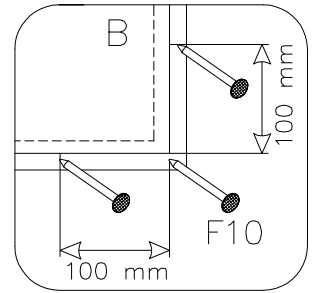
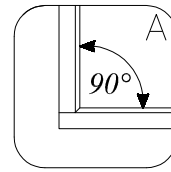
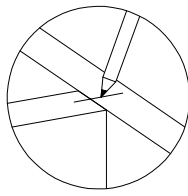

8

4.0x27mm

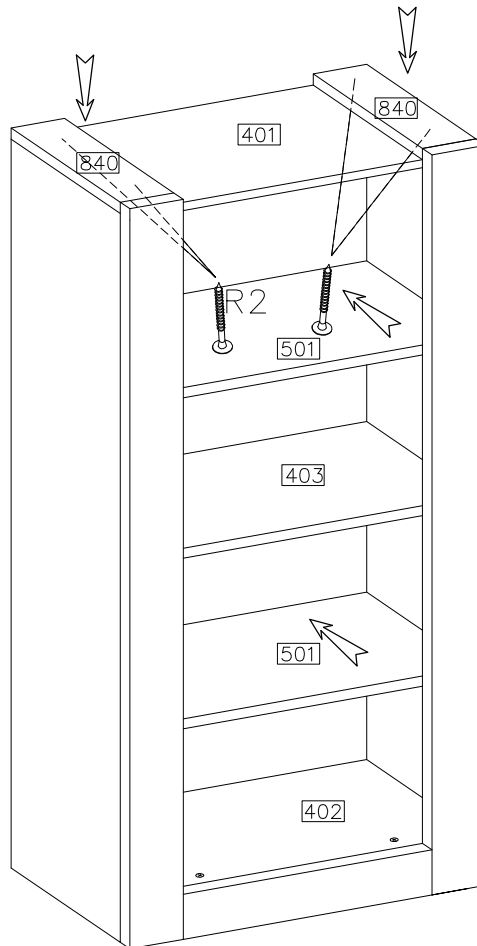

R2
4

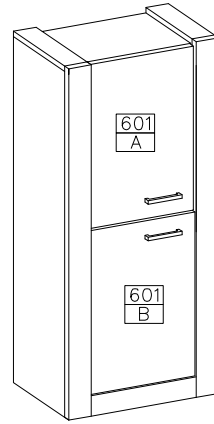
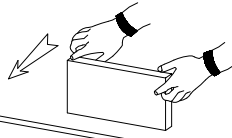
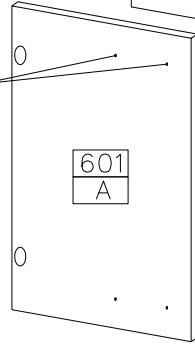
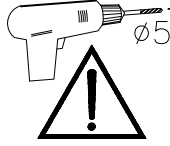
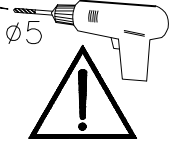
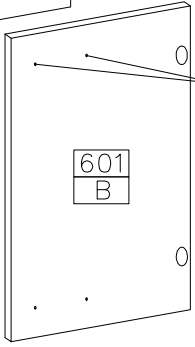
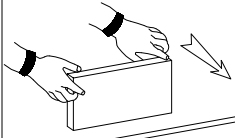
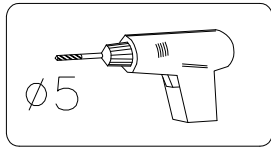

9

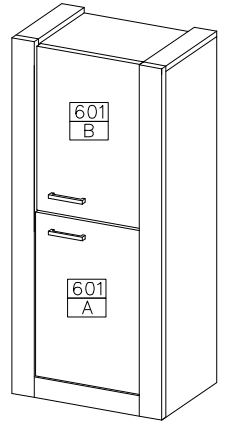

VERSION-L



VERSION-R

10

	M4.0x23 	\varnothing 4.0x16mm 	\varnothing 35/KR90
S1	R2	P1	G9
2	4	8	4

