

SZANTAL – 1D

VERSION-L

VERSION-R

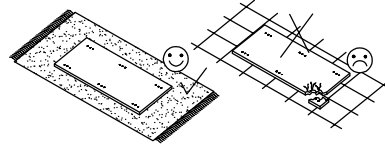

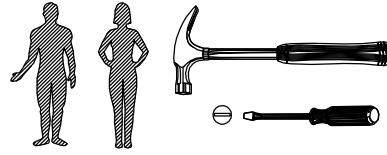
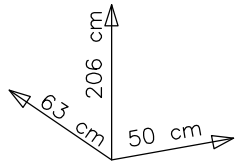
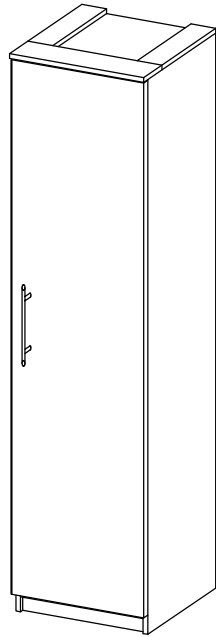
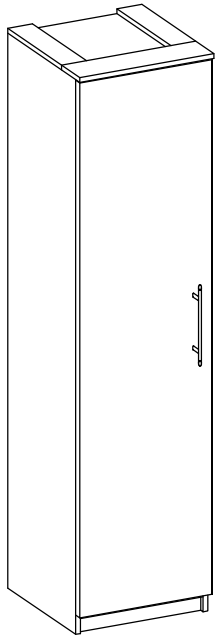

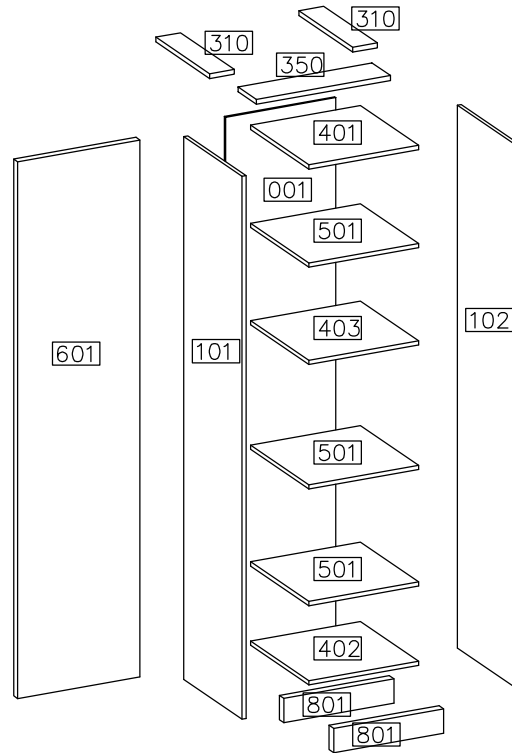
#	ART. NR	QUANTITY
1	401	1
2	402	1
3	403	1
4	501	3
5	101	1
6	102	1
7	601	1
8	801	2
9	001	1
10	350	1
11	310	2

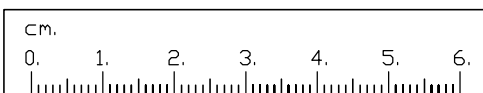

D1	$\varnothing 15/12\text{mm}$ C	E	$\varnothing 8 \times 30\text{mm}$ A	H=0 H4	$\varnothing 35/\text{KR}-0$ G6	$\varnothing 4.0 \times 16\text{mm}$ P1
12	12	12	16	3	3	6
F10	S1	$4.0 \times 27\text{mm}$ R2	J4	F1	J6	O11
50	1	6	12	6	2	1





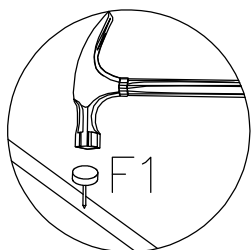
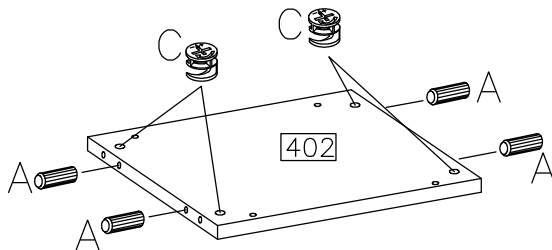
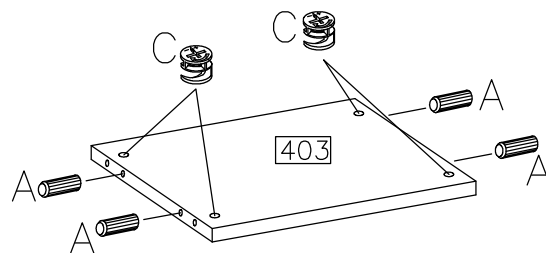
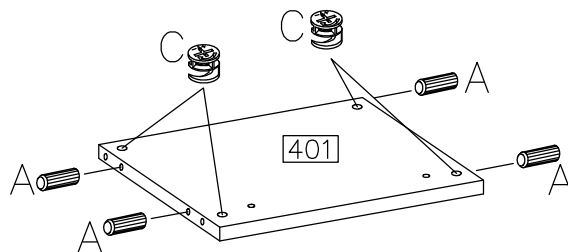
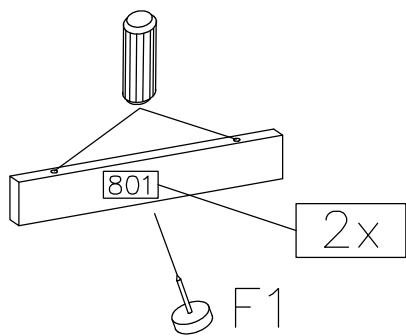

1

	$\varnothing 15/12\text{mm}$ 	$\varnothing 8 \times 30\text{mm}$ 
F1	C	A
2	12	16



2

	
D1	J4
12	12
	
H=0	F1
3	4

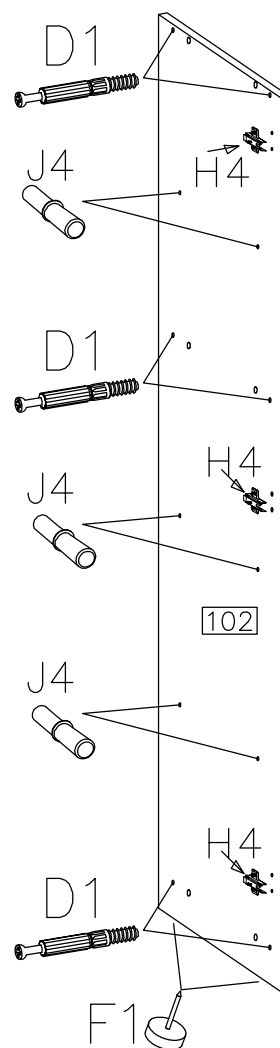
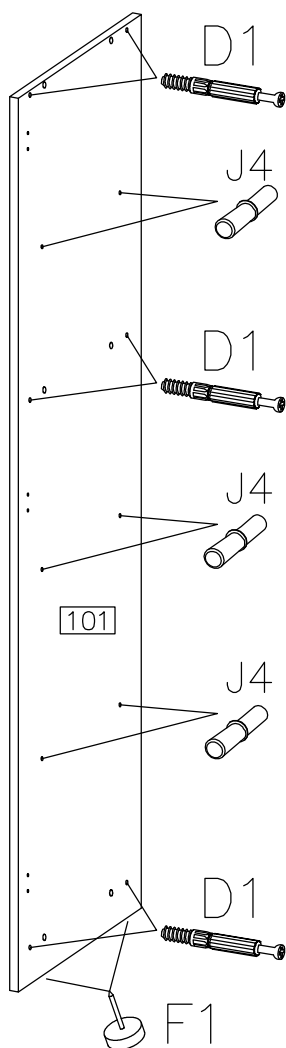

VERSION-R

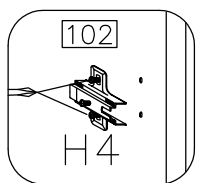

VERSION-L

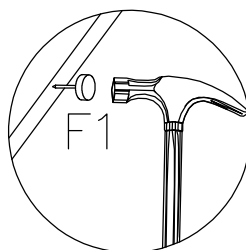
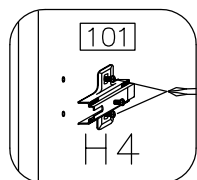

3

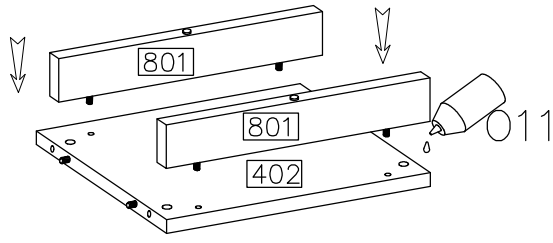
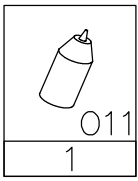

4

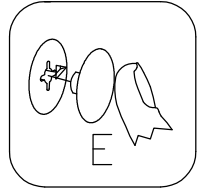
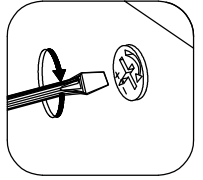
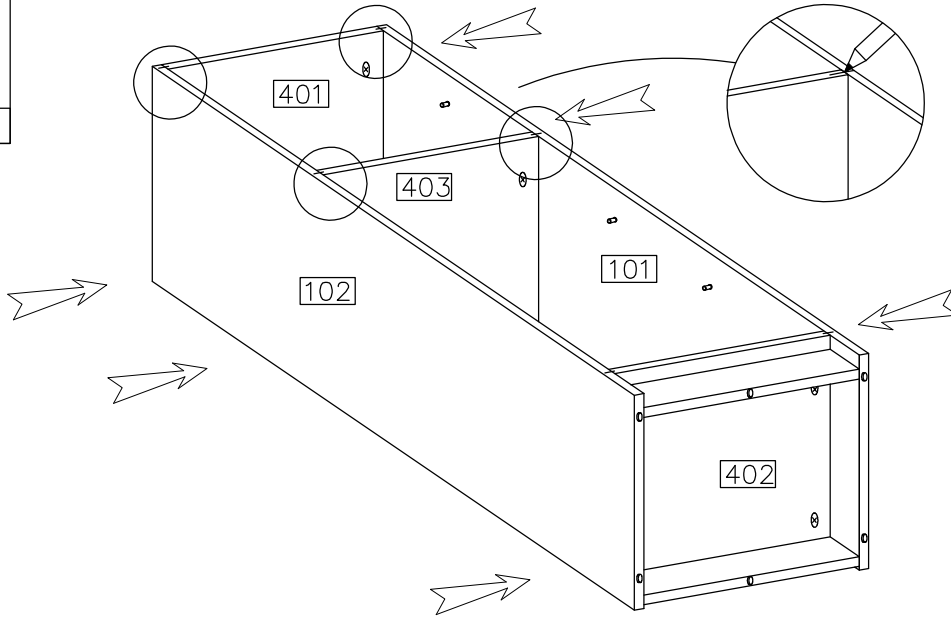
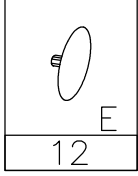

5

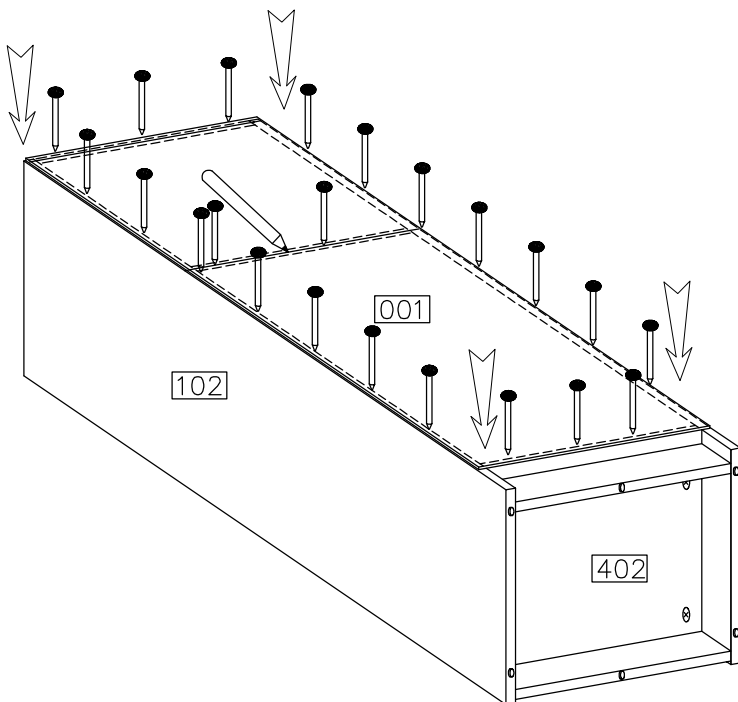
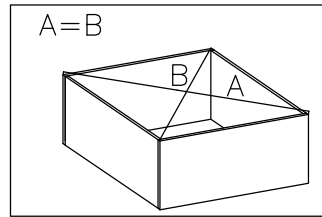
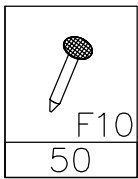

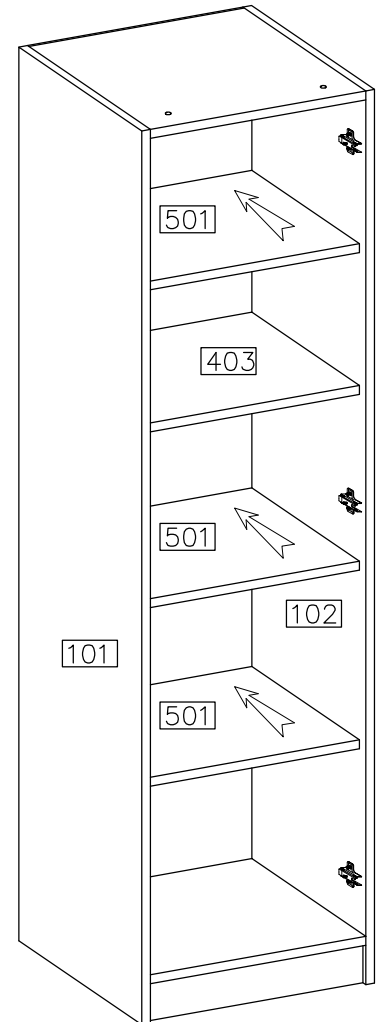

6



7

- 

ø35/KR-0
G6
- 3
- 

ø4.0x16mm
P1
- 6
- 

S1
- 1
- 

4.0x27mm
R2
- 2

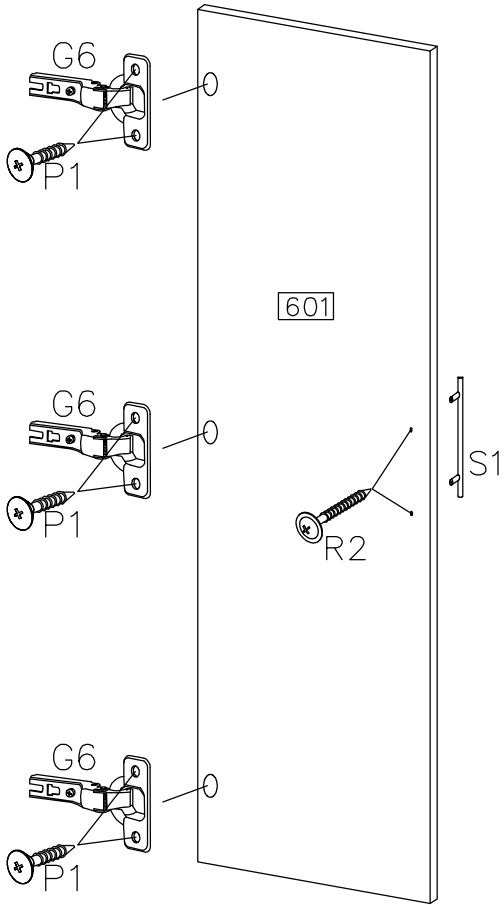

8

- 

4.0x27mm
R2
- 4
- 

J6
- 2

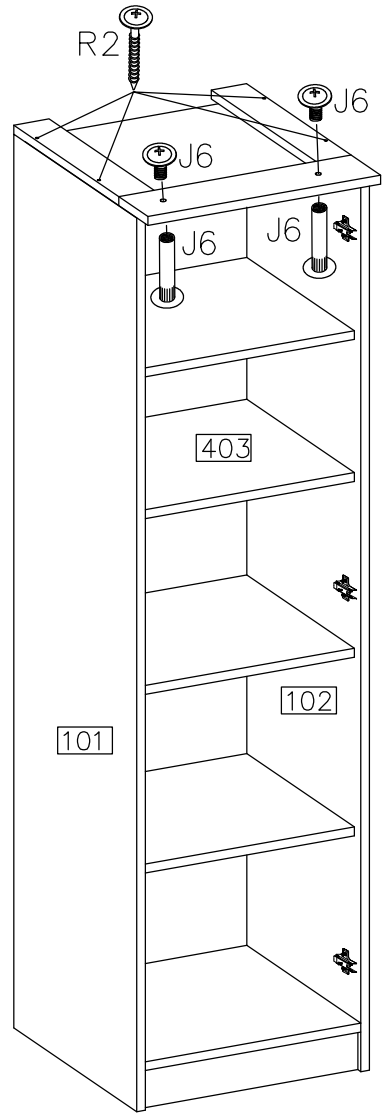

9

VERSION-R

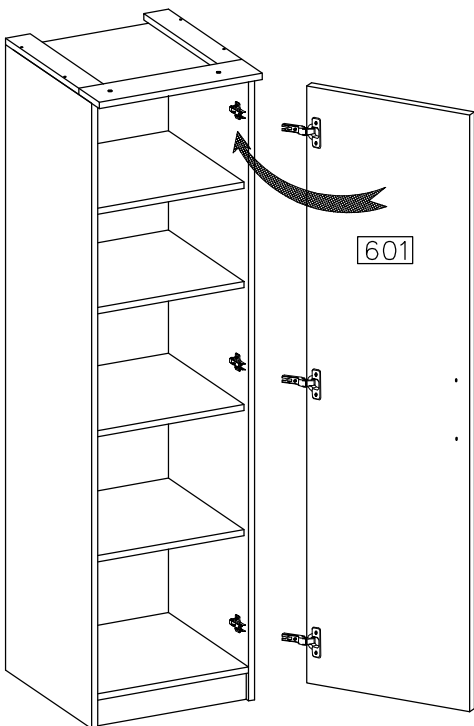

VERSION-L

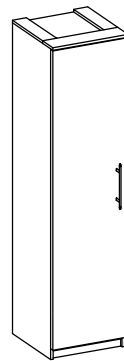

VERSION-R

